

RN20 VL-2



UNIQUE SELLING POINTS



- Stainless steel tools
- Stainless steel frame
- Frequency controlled motor
- 4 programs
- Digital timer
- Table and floor model
- Marine version available

TOOLS IN STAINLESS STEEL



20 L hook in stainless steel



20 L whip in stainless steel



20 L beater in stainless steel



20 L bowl in stainless steel

OPTIONS



Fixed safety guard grid



Automatic scraper



Attachment drive



Removable guard, stainless steel



Removable guard, plastic

ACCESSORIES



Table for RN20



70 mm meat mincer, 4,5 mm disc, knife



82 mm Meat mincer, 3 mm disc, precutter and knife



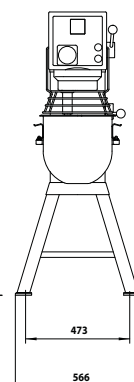
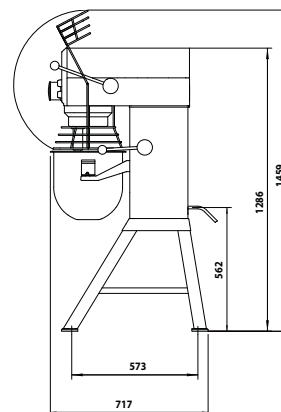
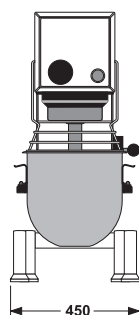
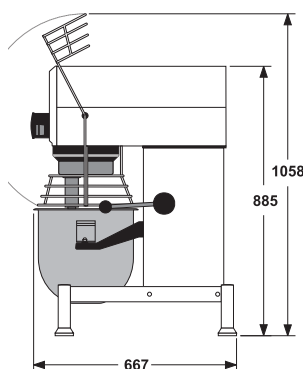

GR20 Vegetable cutter

DIMENSIONS





Item no.	Product	Price Eur	
	Standard features: Mixer as standard in stainless steel A-Equipment 1 Bowl in stainless steel 1 Whip with stainless steel wires 1 Hook in stainless steel 1 Beater in stainless steel 1 Fixed safety guard plastic Timer and emergency stop		
			
M020-A007	Table model, VL-2 control panel - Voltage: 1ph, 230V, 50-60Hz with 0 and ground - 1200 W	4.066 €	
M020-A008	Floor model, VL-2 control panel - Voltage: 1ph, 230V, 50-60Hz with 0 and ground - 1200 W		4.422 €

OPTIONS

Below options can be added to the above mixer (add price)

		+
AP	Removable safety guard plastic	312 €
FG	Fixed safety guard grid - not CE certified	0 €
AG	Removable safety guard grid - not CE certified	312 €
ATT-DR	Attachment drive to fit meat mincer or vegetable cutter	455 €
RN20-B	B-equipment: 1 set of 12L stainless steel bowl, alu. beater, whip and stainless steel hook Used for reduced volume on same mixer ... "2 mixers in 1"	20/12L 603 €
M Table version	Marine version USPHS: Water cover at air ventilation, slotted free screws. Add additional price for marine voltage transformer, see below. Delivery time for marine versions approx. 4 weeks.	482 €
M Floor version	Marine version USPHS: Water cover at air ventilation, slotted free screws. Add additional price for marine voltage transformer, see below. Delivery time for marine versions approx. 4 weeks.	482 €

POWER TRANSFORMER

1 ph, 100V	100V, 50-60Hz without 0 with ground	194 €
1 ph, 110V	110V, 50-60Hz without 0 with ground	194 €
2 ph, 400V	400V, 50-60Hz without 0 with ground	194 €
2 ph, 440V	440V, 50-60Hz without 0 with ground	194 €
2 ph, 480V	480V, 50-60Hz without 0 with ground	194 €

ACCESSORIES 20 L

CR20-A	20 L Set of A-equipment (stainless steel bowl, stainless steel beater, whip with stainless steel wires and stainless	663 €
RN20-75M	20 L Bowl, stainless steel	400 €
R20-78M	20 L Hook, stainless steel	107 €
RN20-27M	20 L Beater in stainless steel	92 €
R20-28M	20 L Whip, standard, stainless wires	133 €
R20-28MS	20 L Whip with 1mm thicker wires	181 €
R20-28MT	20 L Whip with thinner wires	183 €
14R20	20 L Wing whip No. 14, stainless steel	1.073 €
42RN20P	20 L Automatic scraper in stainless steel with nylon blade	551 €
42RN20PT	20 L Automatic scraper in stainless steel with teflon blade	660 €
42RN20-204	20 L Nylon blade for scraper	31 €
42RN20-204T	20 L Teflon blade for scraper	140 €
39RN20	20 L Powder mixer in stainless steel	1.423 €

ACCESSORIES 20/12 L - B-EQUIPMENT USED FOR REDUCED VOLUME ON SAME MIXER... "2 MIXERS IN 1"

RN20-B	20/12 L Set of B-equipment (stainless steel bowl, aluminium beater, whip with stainless steel wires and stainless	603 €
RN20-75AM	20/12 L Bowl, stainless steel	333 €
RN20-78AM	20/12 L Hook, stainless steel	127 €
RN20-27AM	20/12 L Beater, aluminium	88 €
RN20-27A2M	20/12 L Beater in stainless steel	1.031 €
RN20-28AM	20/12 L Whip, standard, stainless wires	133 €
14RN20A	20/12 L Wing whip No. 14, stainless steel	1.073 €
42RN20AP	20/12 L Automatic scraper in stainless steel with nylon blade	536 €
42RN20APT	20/12 L Automatic scraper in stainless steel with teflon blade	560 €
42RN20A-204	20/12 L Nylon blade for scraper	31 €
42RN20A-204T	20/12 L Teflon blade for scraper	140 €

EQUIPMENT

5R1M	Meat mincer, 70 mm - see Meat mincer page for specifications	290 €
6RZ	Meat mincer, 82 mm - see Meat mincer page for specifications	834 €
1130.003	Vegetable cutter, GR20 - see Vegetable cutter page for specifications	1.061 €
48R20Z	Tool rack, 10 - 40L mixers	198 €
24R20RZ	Table in stainless steel	628 €

Bowls and mixing tools in acid-resistant stainless steel (DIN W No. 4436), not goods in stock - contact us for offer.